

ACM

Classic & contemporary venues for corporate and private events



Contents

ACM Floor Plan

ACM Floor Plan 3

Lectures, Seminars, and Stage Performances

Auditorium 5

Auditorium Foyer 6

Discovery Room 7

Demonstration Room 8

Cocktail Receptions, Product Launches, and Corporate Hospitality Events

Riverfront Forecourt 10

Product Launches, Corporate Hospitality Events, and Weddings

River Room 12

River Terrace 13



ACM floor plans

Basement

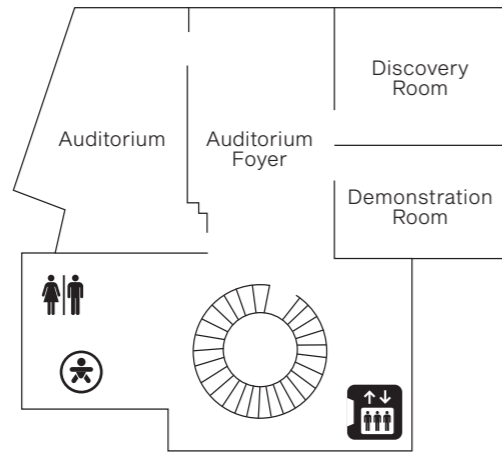

Level 1

- Trade and Maritime Silk Routes Galleries

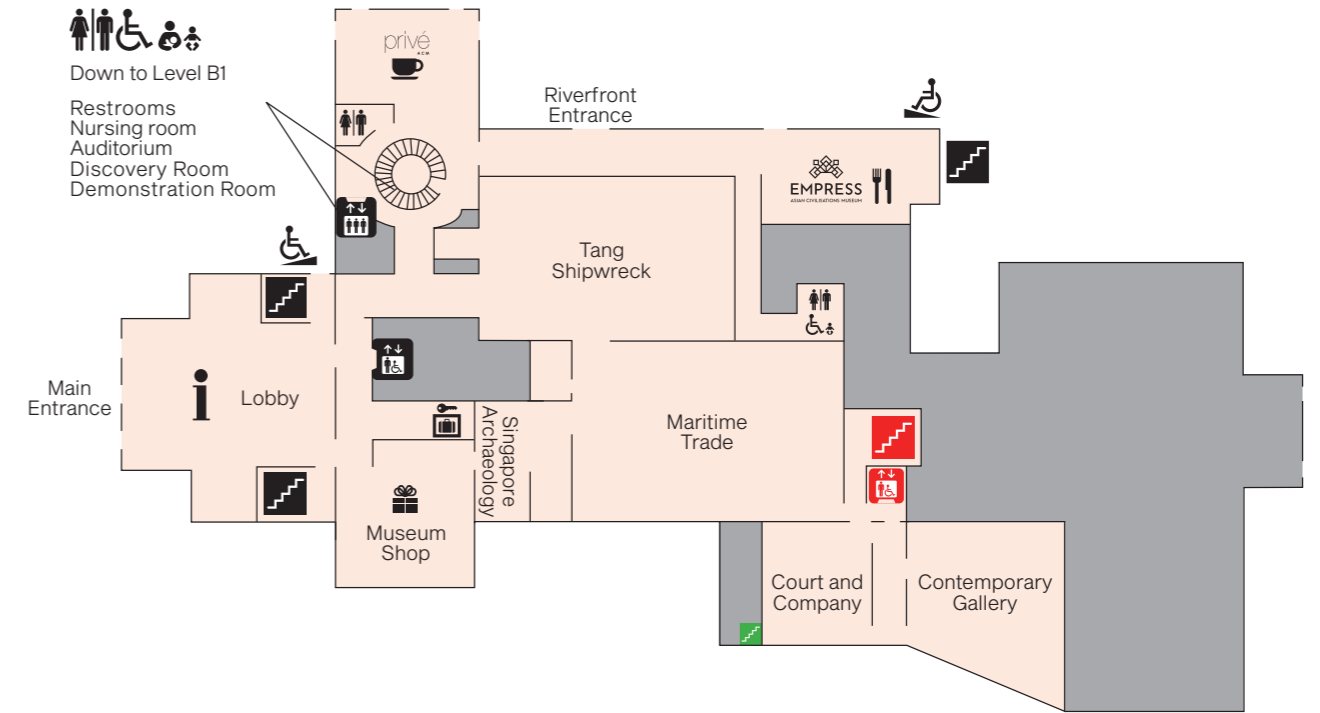

Level 2

- Faith and Belief Galleries

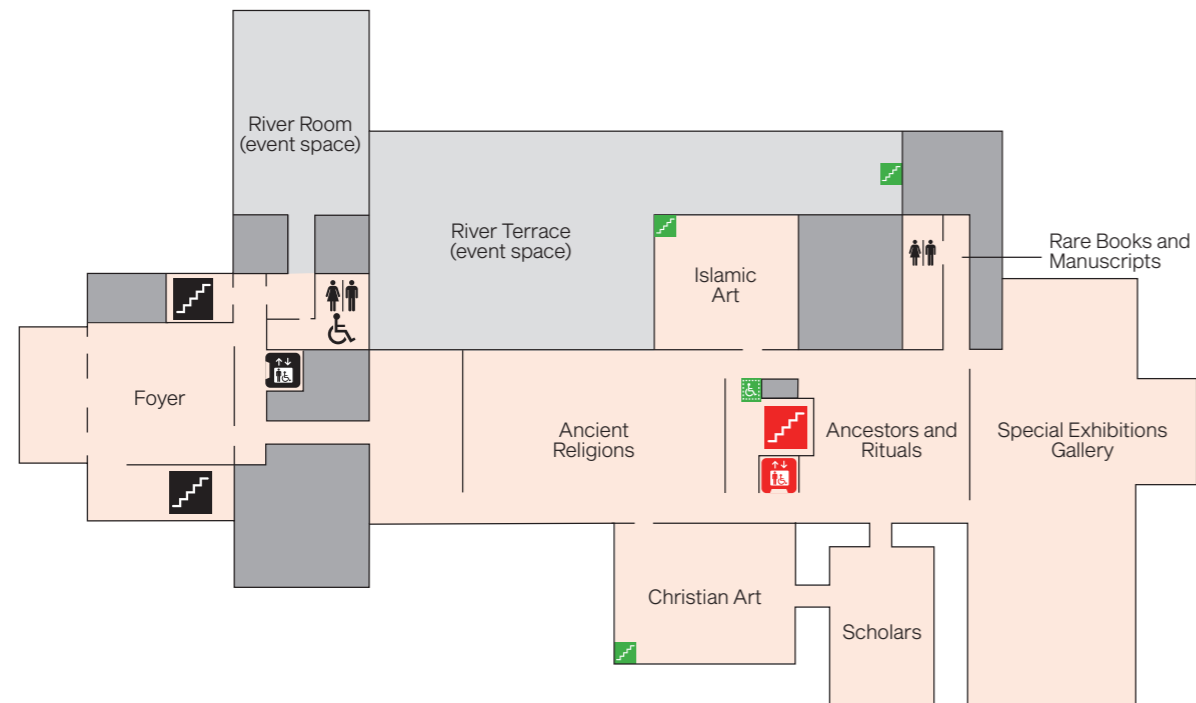

Level 3

- Materials and Design Galleries
(access only via central staircase and platform lift)

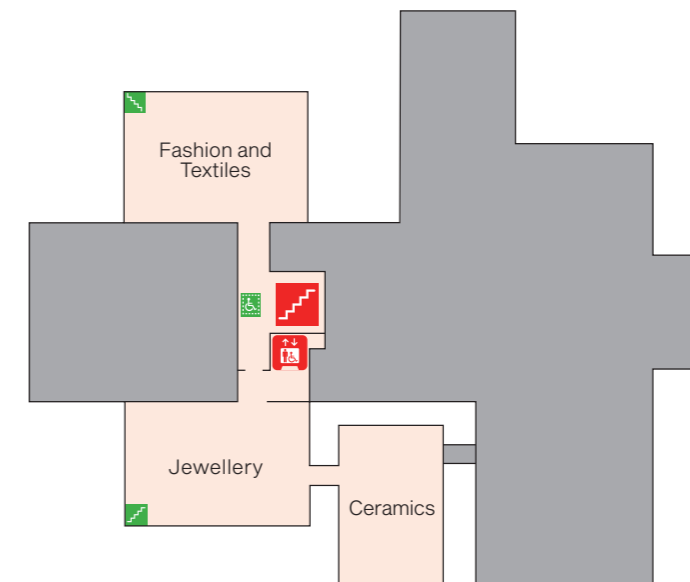

ACM B1 event venues

Lectures, seminars, and stage performances

Auditorium

(GFA: 240sqm)

The Auditorium is equipped with built-in basic sound system, projector & screen, and retractable chairs. Perfect venue for lectures, seminars, and stage performances.

Seating capacity: 182 guests.

Stage Dimension

Length:

5m (nearer to the projector screen) to 6m (nearer to the steps)

Width:

4.2m

Working Height:

2.8m

Elevation from floor to the stage:

0.7m

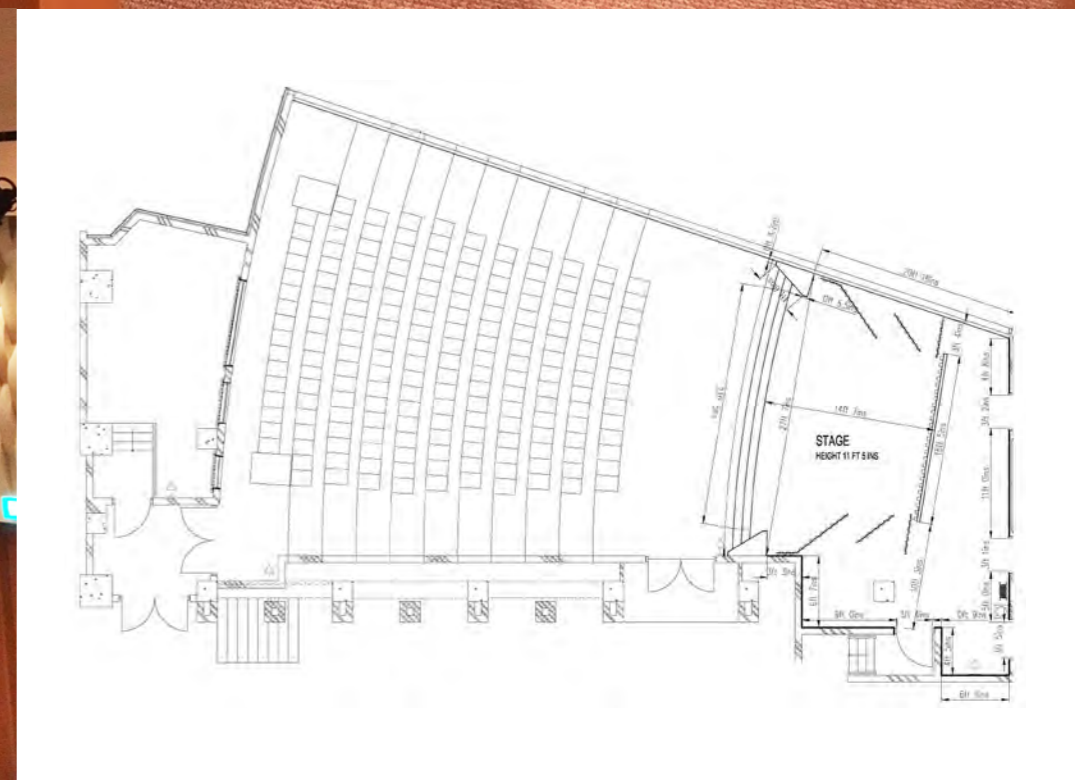

Auditorium Foyer

(GFA: 100sqm)

The Auditorium Foyer is the designated F&B area for events in the Auditorium.

Auditorium and Foyer hire fees

Booking time*	Hire fee**
4 hours (between 9am and 11pm)	\$3,597
8 hours (between 9am and 11pm)	\$5,188.40
Additional hour	\$1,035.50

* Booking time includes event set-up / rehearsal and tear-down / removal.
** Venue hire fee includes prevailing GST rate. The hire fee is correct at the time of printing, ACM will inform clients well in advance of event date should there be changes in the hire fee.

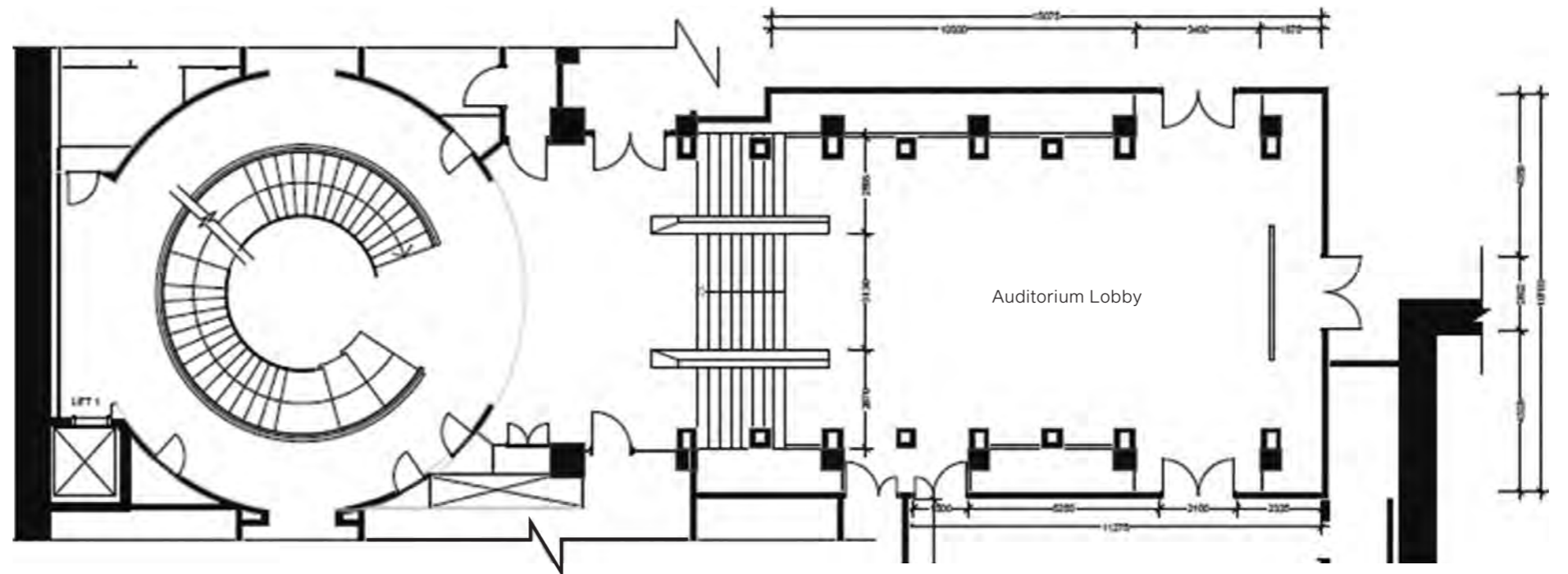

Discovery Room

(GFA: 95sqm)

The Discovery Room is equipped with built-in basic sound system, projector & screen, ideal for meetings, workshops, and demonstrations.

Seating capacity: 70 guests.

Discovery Room hire fees

Booking time*	Hire fee**
4 hours (between 9am and 11pm)	\$2,180
8 hours (between 9am and 11pm)	\$3,226.40
Additional hour	\$599.50

* Booking time includes event set-up / rehearsal and tear-down / removal.
** Venue hire fee includes prevailing GST rate. The hire fee is correct at the time of printing, ACM will inform clients well in advance of event date should there be changes in the hire fee.

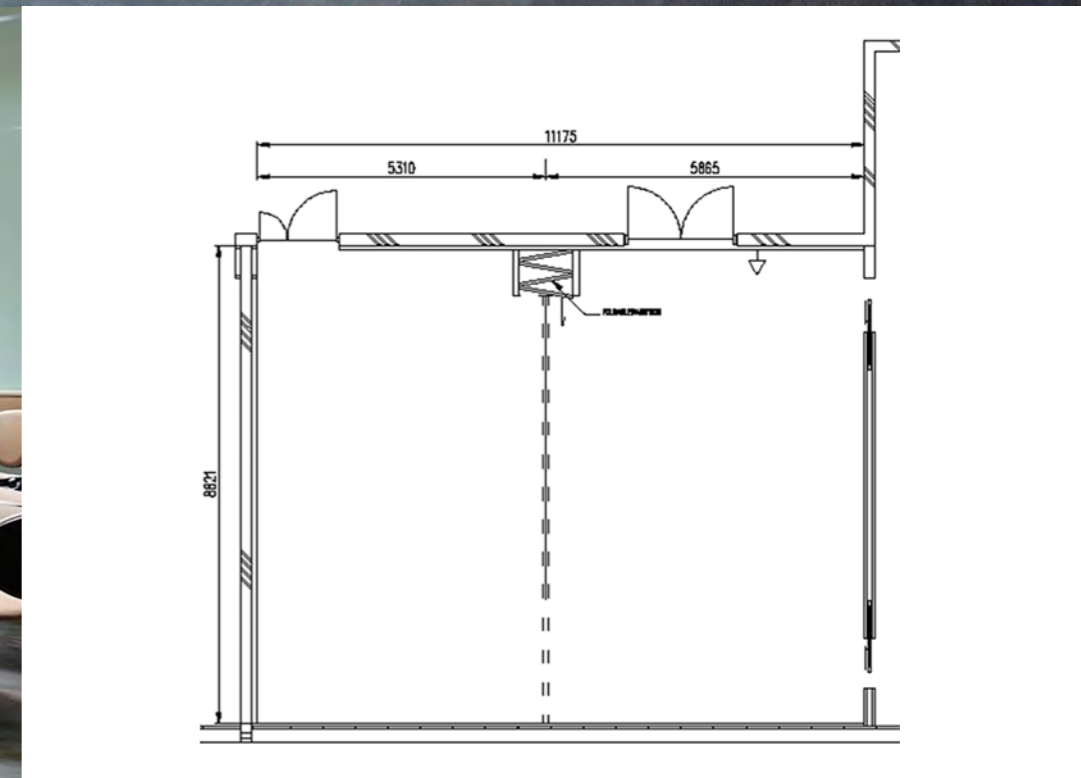

Demonstration Room

(GFA: 46sqm)

The Demonstration Room is equipped with built-in basic sound system, projector & screen, ideal for meetings, workshops, and demonstrations.

Seating capacity: 30 guests.

Demonstration Room hire fees

Booking time*	Hire fee**
4 hours (between 9am and 11pm)	\$1,635
8 hours (between 9am and 11pm)	\$2,681.40
Additional hour	\$490.50

* Booking time includes event set-up / rehearsal and tear-down / removal.
** Venue hire fee includes prevailing GST rate. The hire fee is correct at the time of printing, ACM will inform clients well in advance of event date should there be changes in the hire fee.

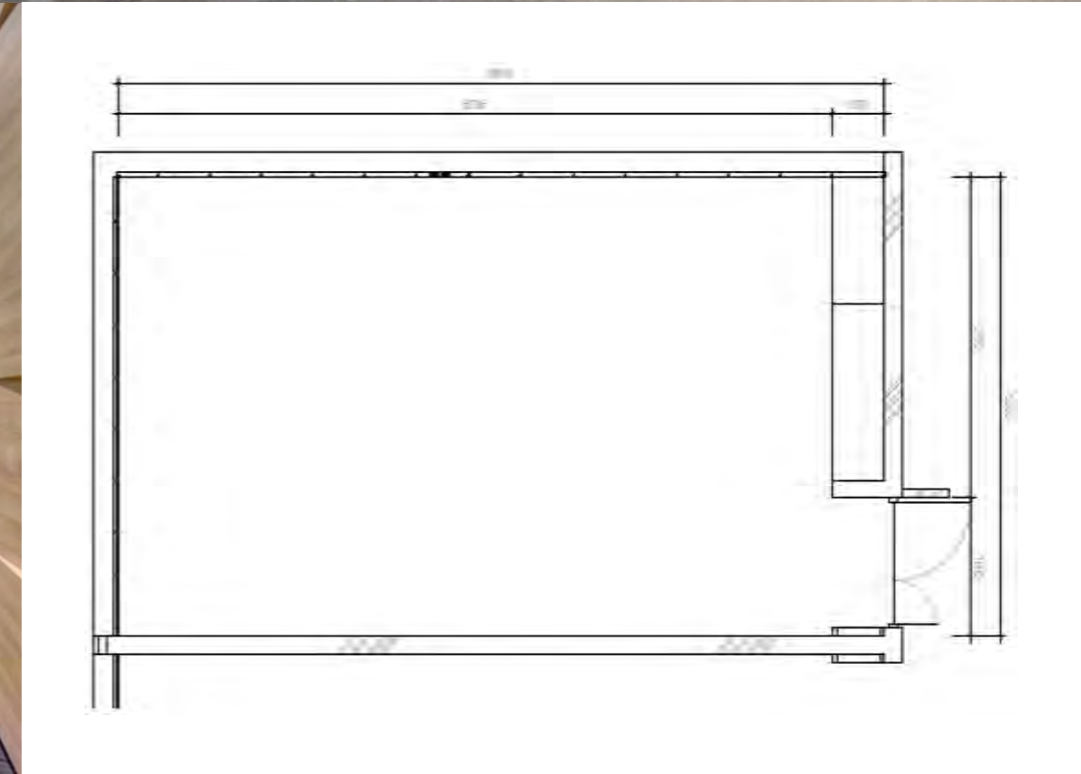

ACM L1 event venues

Cocktail receptions, product launches, and
corporate hospitality events

Riverfront Forecourt

(GFA: 230sqm)

The new outdoor forecourt offers stunning view Singapore River and the central business district; suitable for cocktail receptions, photo booth opportunities, and live performances.

Capacity: 200 guests

Riverfront Forecourt hire fees

Booking time*	Hire fee**
4 hours (between 9am and 11pm)	\$3,695.10
8 hours (between 9am and 11pm)	\$5,545.92
Additional hour	\$740.11

* Booking time includes event set-up / rehearsal and tear-down / removal.
** Venue hire fee includes prevailing GST rate. The hire fee is correct at the time of printing, ACM will inform clients well in advance of event date should there be changes in the hire fee.

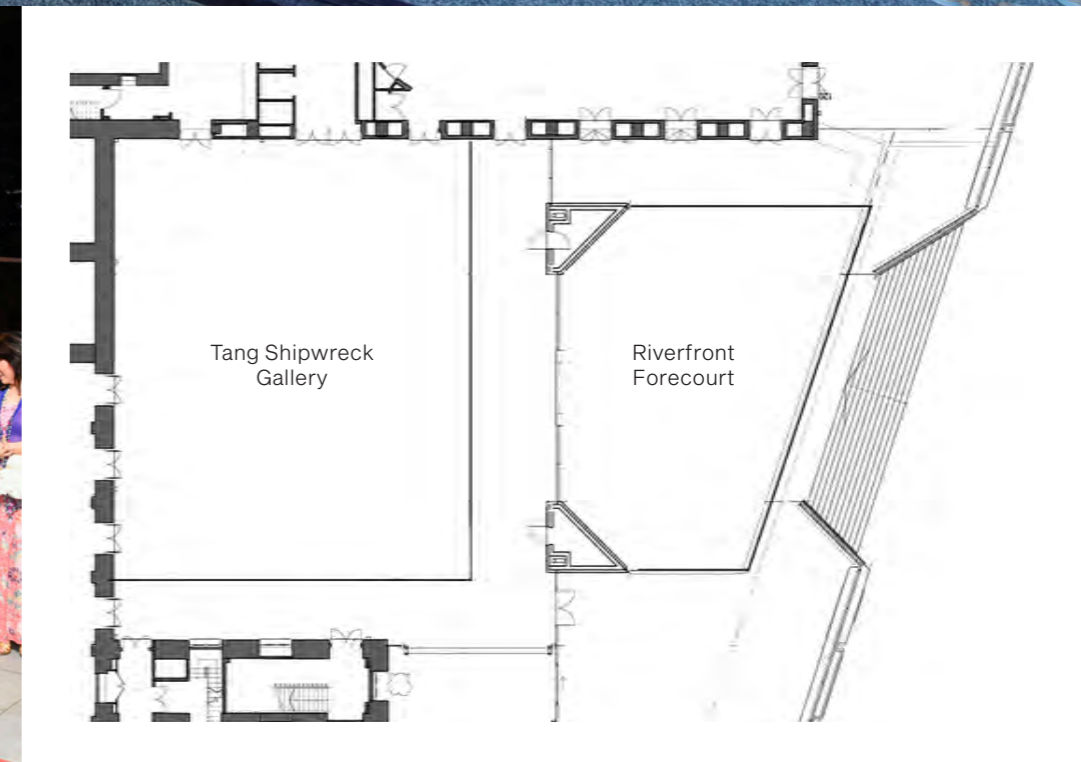

ACM L2 event venues

Product launches, corporate hospitality events, and weddings

River Room

(GFA: 260sqm)

The River Room's contemporary setting is ideal for corporate and private functions such as product launches, cocktail receptions, corporate luncheons/dinners, and weddings/anniversaries.

Seating Capacity: 190 guests.

Portable Stage (GFA: 8.92sqm)

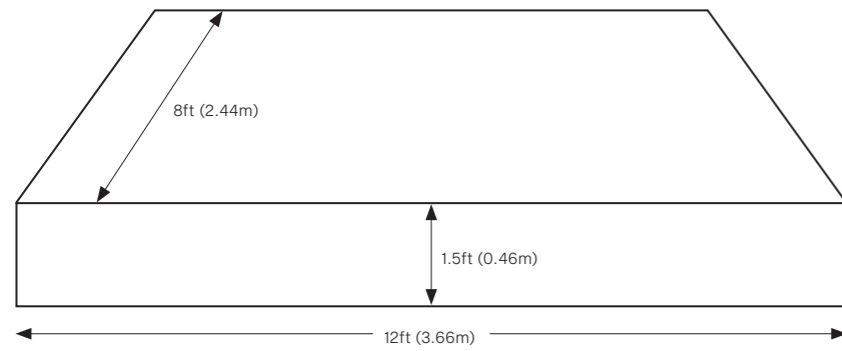

Length: 12ft (3.66m)
Width : 8ft (2.44m)
Height : 1.5ft (0.46m)

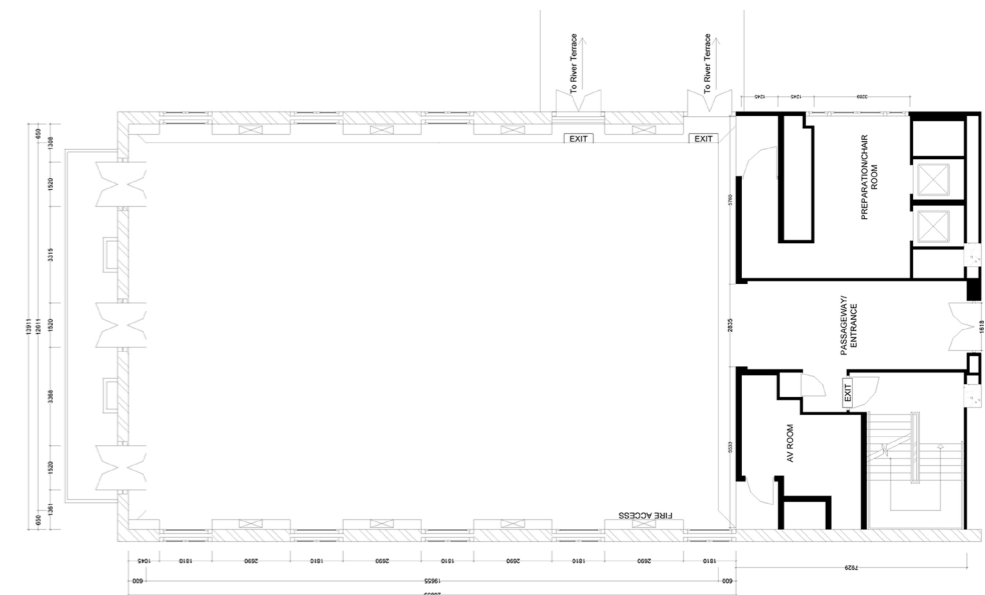

River Terrace

(GFA: 600sqm)

At the River Terrace, guests will enjoy a relaxing outdoor cocktail as they soak in stunning views of the Singapore River, Boat Quay, and Singapore Central Business District. Perfect from sunset till late.

River Room & River Terrace hire fees

Booking time*	Hire fee**
4 hours (between 9am and 11pm)	\$5,123
8 hours (between 9am and 11pm)	\$6,496.40
Additional hour	\$1,035.50

* Booking time includes event set-up / rehearsal and tear-down / removal.
** Venue hire fee includes prevailing GST rate. The hire fee is correct at the time of printing, ACM will inform clients well in advance of event date should there be changes in the hire fee.

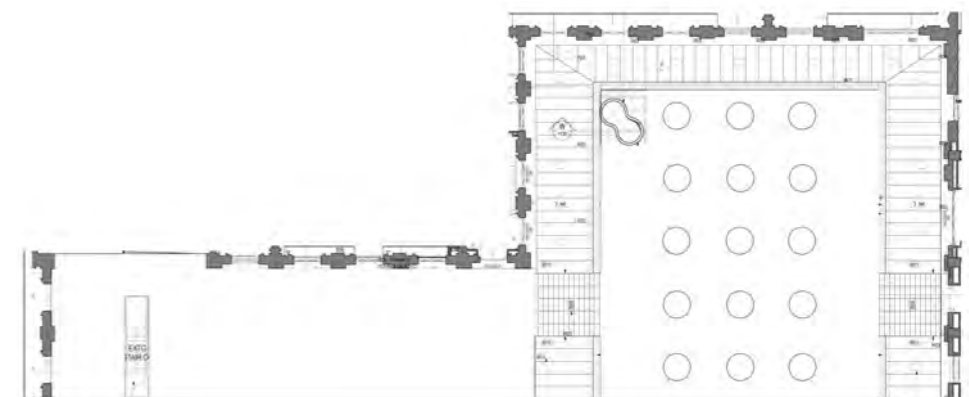

Events Team

Tel: +65 6982 1390 | Email: nhb_acm_bd@nhb.gov.sg